

jaga

CLIMATE DESIGNERS

Heating



Light cooling



Breeze



STRADA AND STRADA HYBRID

LOW WATER CONTENT RADIATOR FOR HEATING AND COOLING





jaga

CLIMATE DESIGNERS

Climate change and evolution of construction techniques demand new ecological solutions for heating, cooling and ventilation.

New technologies have to consume far less energy. They have to ensure a better indoor climate without damaging the outdoor climate. Traditional systems with fire and carbon emissions have to be extinguished. We have to evolve towards a green flame and build a sustainable path towards a better future. Choosing the sustainable path is no longer a matter of choice, it's an obligation.

Always honouring its values, Jaga Climate Designers continually look for the most ecological solutions for heating, cooling and ventilation.

***A COMFORTABLE INDOOR
CLIMATE YEAR ROUND
WITH MINIMAL IMPACT ON
THE OUTDOOR CLIMATE***

STRADA

Warmth and efficiency
with cutting-edge design

- Slimline, contemporary design radiator that is discreet and enhances any room.
- The sustainable choice, less material, fast to respond, highly efficient and recyclable.
- Compact size and high power output using low water content (Low-H₂O) heat exchanger technology.
- Ideally suited to renewable energy systems with low flow water temperature.
- Safe-to-touch casing in standard white and grey colours, with other colour options and finishes also available.
- Can offer cooling via Jaga's Dynamic Boost Hybrid (DBH) technology and ventilation via Jaga's oXygen system.



design award
winner



STRADA

LOW-H₂O: LIGHTER, FASTER, MORE EFFICIENT

THE LOW WATER CONTENT RADIATOR

Jaga's Low-H₂O radiators contain 90% less water than that of a steel panel radiator, so they are faster to heat up and cool down. This means Low-H₂O radiators react faster to the occupants' needs as well as changes to ambient temperature. This ensures better comfort with less energy consumption, no wasteful over-heating and reduced demand on the heating system itself. They also have no heavy steel panels that require pre-heating, are far lighter to install and remain much lighter when fully filled during usage.

The ultra-modern aluminium and copper heat exchanger, which comes with a 30 year guarantee, provides rapid, energy-efficient heat to any space.

Research by Dutch certification and testing body, KIWA, shows that Low-H₂O radiators consume between 9 and 16%* less energy than a system with steel panel radiators. They achieve the desired temperature faster with less heat wasted through unnecessary over-heating, common in heavier radiators.



Comparison Low-H₂O/panel radiators

	Water temp. > 50°C Saving	Water temp. ≤ 50°C Saving
Renovation	13%	16%
New-builds	9%	10%

COMPARISON OF RESPONSE TIME TO TEMPERATURE CHANGES

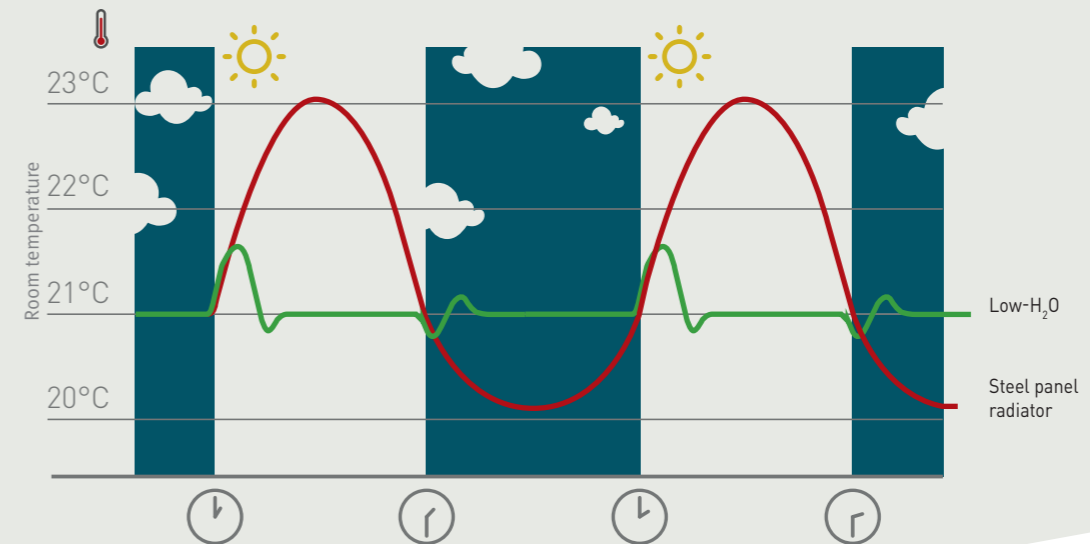

THERE IS A CLEAR CONNECTION BETWEEN THE WEIGHT OF THE RADIATOR, ITS REACTION TIME AND THE ENERGY SAVINGS IT OFFERS.

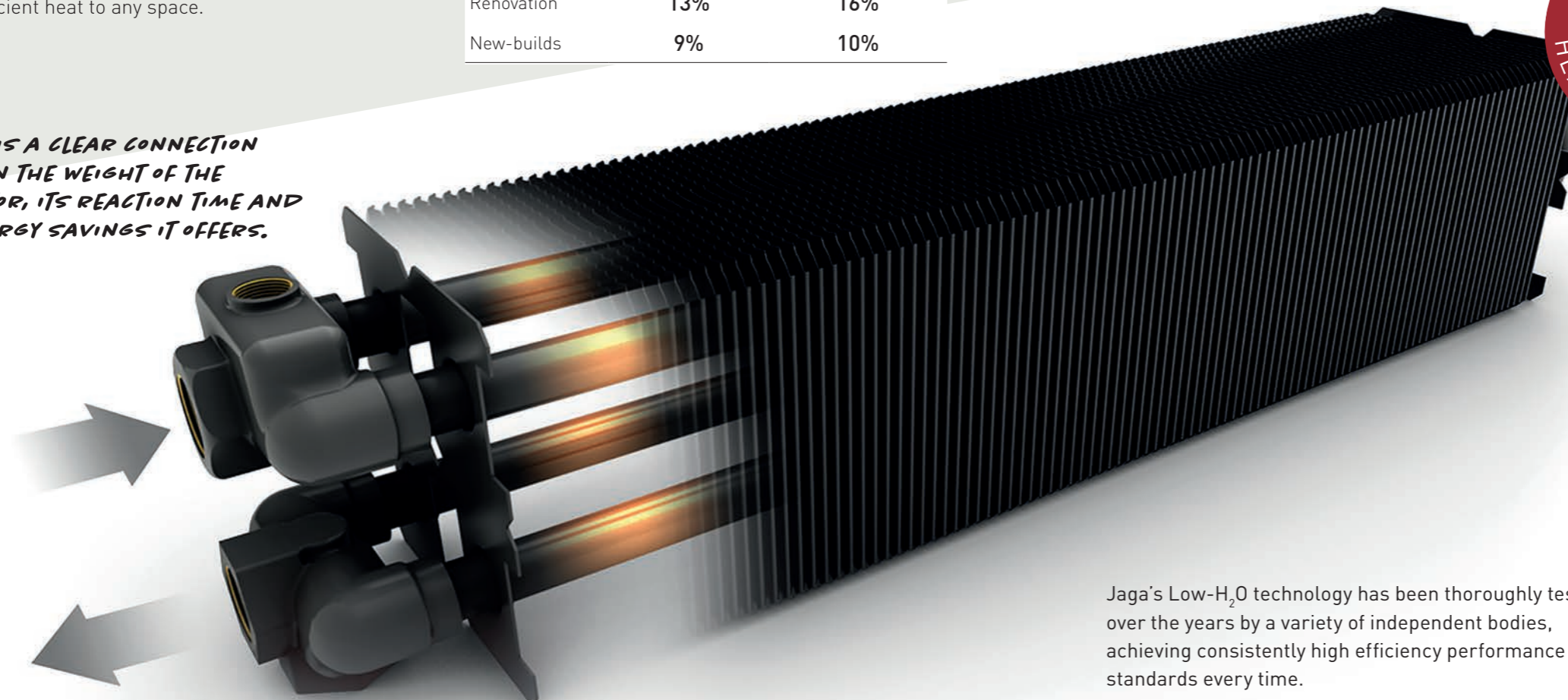

FASTEST RESPONSE TIME FOR MAXIMUM COMFORT.



RESPECT NATURE

Jaga's Low-H₂O technology has been thoroughly tested over the years by a variety of independent bodies, achieving consistently high efficiency performance standards every time.

Low-H₂O radiators are more efficient at all water temperatures, making them the perfect partner for renewable systems and boilers alike.

In all conditions Low-H₂O radiators achieve the maximum scores set by ISSO. Without a maximum score*, the Low-H₂O exchanger would achieve even higher. KIWA found Low-H₂O to be at least 5% more economical than underfloor heating.

*The minimum required score is 1.00 (100%) for Low-H₂O as per the quality declaration, and average score of 0.05 (95%) for underfloor heating, according to NEN7120, Table 14.1, delivery efficiency up to 8m.

STRADA HYBRID

The only radiator that provides heating, cooling and ventilation

Always leading the way in sustainable HVAC innovation, Jaga has developed pioneering technology with Dynamic Boost Hybrid (DBH).

DBH provides high outputs with all water temperatures, hot and cold, making it perfectly suited to heat pumps and other renewable energy systems.

DBH is an enhanced version of Jaga's former Dynamic Boost Effect (DBE) technology, utilising small electric activators inside the unit to significantly boost output. But with the added benefit of providing light cooling.

- All the benefits of Strada, but even more compact and more powerful with DBH.
- The ultimate radiator solution for low flow temperatures associated with renewable energy technology.
- Low-cost light cooling when used with reverse cycle heat pumps providing cooled water.
- Breeze functionality offering ambient air circulation.



STRADA HYBRID

DBH: DOUBLE OUTPUTS + COOLING WITH HEAT PUMPS

ONE ECO FRIENDLY SOLUTION

Heat pumps and solar thermal energy generally require much larger radiators as they operate with very low water temperatures that often don't exceed 35°C. Low-H₂O radiators do not need to increase in size when working with lower water temperatures.

With DBH technology, the same heat output can be achieved from a similar size radiator compared to a radiator working with a gas or oil fired heating system, allowing the installation of renewable heating systems without compromising on comfort and aesthetics.

- Efficient and effortless heating with heat pumps and low temperature boilers.
- Suitable for environmentally friendly light cooling (non-condensing) in combination with any heat pump that can supply cooling water.
- Easy installation on almost all new and existing Jaga Low-H₂O heating units.



THE SAME OUTPUT AT ALMOST HALF THE SIZE OF A STEEL PANEL RADIATOR

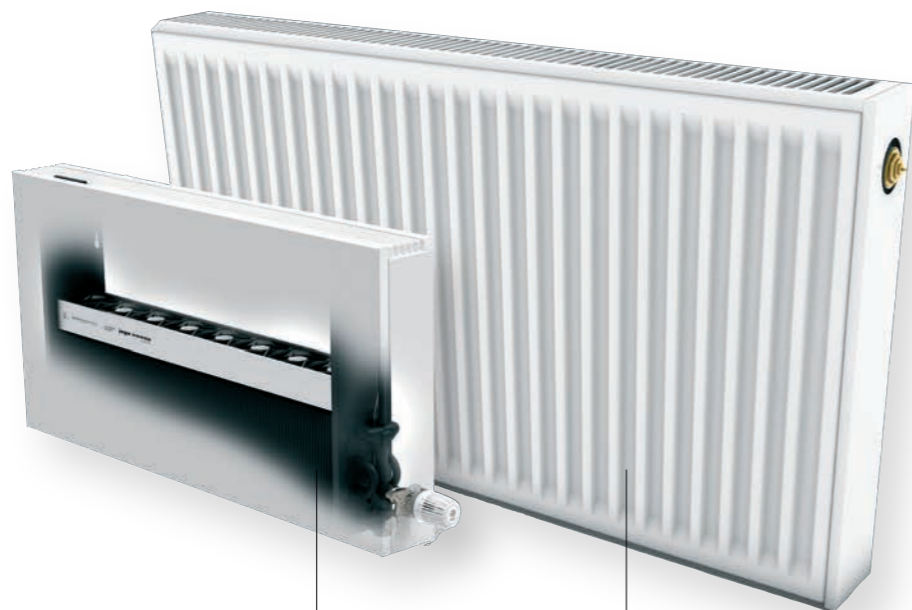

Jaga Strada Hybrid T11
Size: 50 cm x 100 cm
Output: 1173 Watts*
Weight: 16.7 kg
Water content: 1.3 litres

Steel Panel Heater
Size: 70 cm x 180 cm
Output: 1210 Watts
Weight: 73 kg
Water content: 13.7 litres

Based on conditions of 45/40/20

* maximum heat capacity



INTELLIGENT OPERATION

DBH has a simple control panel to adjust settings and modes, with automatically dimming coloured LED lights to indicate the selected setting.

There are three alternative configurations set at time of order: TPT (Temperature control) (default), ACO (Auto-changeover), BMS (Building Management System control).

TPT configuration (default): mode button can be used to switch between Heating and Cooling modes.

- Thermal activators run once the water temperature is above set-point (28°C default) and the measured room temperature is below the set-point, speeding up and slowing to achieve the desired room temperature.
- Boost mode can be activated where thermal activators run at max. speed for 15 minutes.

ACO configuration: mode button can be used to switch between Heating, Cooling and Breeze modes.

- Thermal activators run based on water temperature and chosen fixed speed.
- Breeze mode can be selected whereby the thermal activators operate independently of water temperature.

BMS configuration:

- DBH can be connected to an external controller, such as BMS or room thermostat to control thermal activator speed and changeover remotely. Please contact Jaga's technical team for more information.

FAQs

WHAT IS JAGA LIGHT COOLING ?

Light cooling (also referred to as 'non-condensing cooling') is a form of gentle cooling whereby the water temperature is always higher than the condensing temperature (or dew point), usually around 15°C depending on weather conditions, and therefore no condensation water is formed. This is an energy-efficient way of cooling that's ideal in combination with low temperature heating.

HOW MUCH ENERGY DOES LIGHT COOLING USE ?

The energy consumption is lower than with low temperature cooling systems such as air conditioning systems, especially in combination with a ground source heat pump.

WHAT MAKES JAGA THE SUSTAINABLE CHOICE?

Sustainability does not just start when the product is in use, but from the sourcing of the materials and throughout the product life cycle. Being sustainable and reducing our impact on the environment is what we do. There is no Planet B. One of Jaga's company values is to respect nature, and this is at the heart of everything we do.

HIGHEST EFFICIENCY RATINGS

Jaga's Low-H₂O uses less energy than any other radiator and contains 90% less water than that of an equivalent steel panel, meaning faster response times and no wasteful over-heating.

BUILT TO LAST

The heat exchanger consists of aluminium heating fins, copper and brass irrigation tubes and brass collectors. Totally rust-free, resistant to very high working pressures and with a 30-year guarantee. A long life means lower environmental impact.

EFFICIENT USE OF MATERIALS

Since copper and aluminium are such efficient heat conductors, only a relatively small quantity of these materials are required, this includes the casing. A Low-H₂O radiator weighs much less and uses a lot less materials than a steel panel radiator.

FULLY RECYCLABLE

Copper and aluminium are highly efficient, long-life materials, and crucially, they are always fully recyclable. The use of these materials contributes to an improved LCA score.

"LOW-H₂O RADIATORS REDUCE THE CO₂ EMISSIONS OF AN AVERAGE HOUSE BY ABOUT 1000 KG."



RESPECT NATURE

JAGA LOW-H₂O RADIATORS REDUCE WASTE

Life cycle analysis (LCA) according to the Ovam Ecolizer database and weight. Example for a 10 kW heating system, 45/35/20 temperature profile.

	Underfloor Heating	Cast Iron Radiator	Steel Panel Radiator	Jaga Low-H ₂ O Radiator
LCA Score	248700	248744	185853	66517
Total Weight incl. Water (kg)	6252	360	216.7	48.8

What is an LCA score?

LCA or 'Life Cycle Assessment' is a system designed to compare products and their overall impact on the environment. This looks at all processes from design, materials sourced, manufacturing, and energy usage until the product is ultimately 'retired'. Governments are trying to standardise LCA systems and to integrate them into the legislation. Jaga uses Ovam's Ecolizer 2.0 based on the Eco-Indicator EI-99 database. The lower the LCA score, the less adverse impact on the environment. Jaga Low-H₂O radiators consistently score significantly better than other radiators or heating systems.



BEST LCA SCORE



TECHNICAL INFORMATION

STRADA - DIMENSIONS

in mm

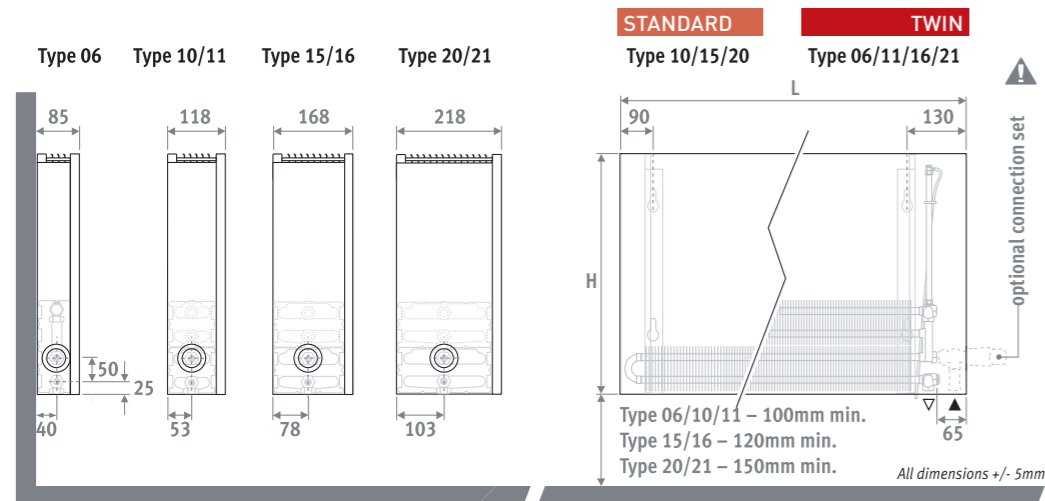

DELIVERY

All Stradas are made to order. Split deliveries option available. Please contact our customer service team to discuss your requirements.

Package includes:

- Low-H₂O heat exchanger with wall brackets and fixing kit, air vent 1/8" and drain plug 1/2".
- Casing for connection left or right at low level.
- Cover plate in stainless steel effect for the side panel at the opposite end from the valve.

COLOURS

Environmentally friendly, scratch-resistant, high UV resistant powder coating. See colour chart document for full details of our standard and special colours.

CONNECTION

Standard connection: Bottom end left or right, to the wall or to the floor. Connection to the wall via the bottom of the casing, or totally concealed within the casing, depending on the valve or connection set chosen.

Optional high level valve: add to the code of the radiator /30 (left) or /60 (right)

E.g. STRW.035 050 06.xxx/60

For more details, see 'Valves, TRV Heads and Accessories' on p28.

Optional remote controlled valve:

add to the code of the radiator /00.

E.g. STRW.035 050 06.xxx/00



ORDERING CODE

code	height	length	type	colour
STRW .	020	050	10 .	XXX
enter colour code				

TOWEL RAIL

in chrome-plated aluminium

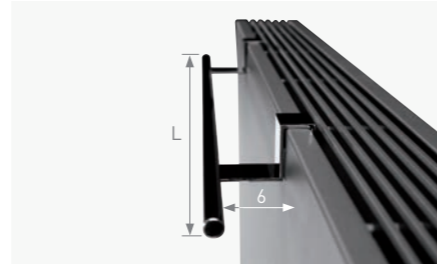

CODE	L
5501.001	560
5501.002	660

STRADA HYBRID - DIMENSIONS

in mm

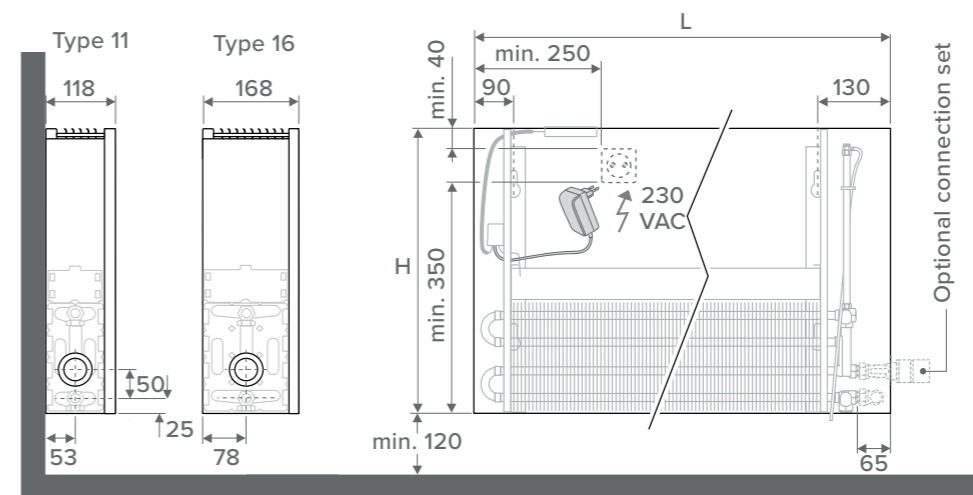

DELIVERY

All Strada Hybrids are made to order. Split deliveries option available.

Please contact our customer service team to discuss your requirements.

Package includes:

- Low-H₂O heat exchanger with wall brackets and fixing kit, air vent 1/8" and drain plug 1/2".
- Casing for connection left or right at low level.
- Cover plate in stainless steel effect for the side panel at the opposite end from the valve.
- Easy to install DBH unit with operation, control and 24VDC power supply.
- Clear installation instructions.

This heater is not equipped with a condensation monitor. It has to be integrated into the installation (only for cooling).

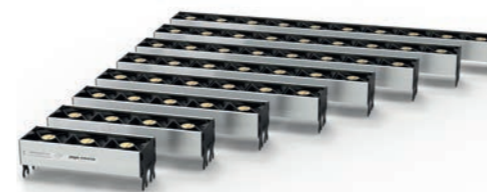

DBH UNIT 10



DBH UNIT 15

COLOURS

The DBH unit sits inside the Strada Hybrid. Therefore outer casing colour information remains the same as for standard Stradas.

ELECTRICAL CONNECTION

The DBH system requires an electrical outlet near the heating unit. If it has a height of 500mm, 650mm and 950mm an electrical outlet or power cable can be installed in the casing. If the height is 300mm, only the power cable can be installed inside the casing. Connection to an external electrical outlet is always possible. Do not connect the electrical and hydraulic connection to the same side of the coil.

HYDRAULIC CONNECTION

Heating

Supply/return on the bottom left or right, to the wall or floor. Wall connection via bottom or completely invisible within the cladding with valve set 225/265.

Heating and cooling

The same connections and valve sets can be used for heating and cooling as for heating only. For the valve sets, use the version with the Heimeier thermostat head HC for heating and cooling or the version with a manual valve.

OPERATION OF DBH SYSTEM

- Suitable for heating or heating + cooling.
 - Noise level monitoring, officially measured according to ISO 3741:2010.
 - Coloured LEDs indicate setting.
 - The DBH system will not control the heat pump or the boiler and therefore cannot replace a room thermostat.
- In the UK, Strada Hybrid is equipped with the DBH control in TPT mode (temperature control) by default. If you require ACO mode or BMS mode, this must be configured at time of ordering so must be included in the ordering code.

In TPT, the thermal activators run once the water temperature is above set-point (28°C default) and the measured room temperature is below the setpoint.

The room temperature set-point is selectable using the push button controller between 16°C and 26°C.

The thermal activators run at a maximum speed to achieve the equivalent noise level of 30dB(A), therefore the speed varies depending on radiator length.

The thermal activators will speed up and slow down to achieve the desired room temperature, switching off if the room temperature is achieved. The water temperature set-points and the maximum fan speed can be adjusted using the control panel.

Boost mode: can be activated by the user by pressing and holding the + button, providing the water temperature is above the set-point. The thermal activators will run at maximum speed for 15 minutes, then revert to temperature control as detailed above. If water temperature drops below set-point, the thermal activators will switch off.

Cooling mode: the aforementioned operation is reversed, the default water temperature is set to 24°C and the room temperature range is between 31°C and 21°C. For the thermal activators to operate, the water temperature must be below set-point and the room temperature must be above set-point.

ORDERING CODE

code	length	unit type	control strategy
DBHS .	060	10 /	TPT

The order code for the DBH set is made up of:

1. Order code to indicate it is a complete set - DBHS,
2. Nominal element length to which it is being fitted - 060, 070, 080, ...280,
3. Activator type - 10 or 15,
4. Control strategy - TPT, ACO or BMS.

Example - DBHS.12010/TPT = DBH set to suit 120cm long heat exchanger type 10 or 11, with temperature control strategy.

DBH to be ordered in addition to Strada to make Strada Hybrid.



HEIGHT 200 - OUTPUT TABLES STRADA

STRW.020 LLL TT.XXX

L mm	SINGLE		WEIGHT	WATER CONTENT	TWIN		WEIGHT	WATER CONTENT		
	Type	Watts 75/65	Watts 55/45	kg	l	Type	Watts 75/65	Watts 55/45	kg	l
500	-	-	-	-	-	06	269	131	3.4	0.26
	10	328	159	3.8	0.33	11	-	-	-	-
	15	545	265	4.7	0.49	16	-	-	-	-
	20	766	373	5.7	0.66	21	-	-	-	-
600	-	-	-	-	-	06	323	157	4.0	0.31
	10	393	191	4.5	0.39	11	-	-	-	-
	15	654	319	5.6	0.59	16	-	-	-	-
	20	919	448	6.8	0.79	21	-	-	-	-
700	-	-	-	-	-	06	377	183	4.7	0.36
	10	459	223	5.3	0.46	11	-	-	-	-
	15	763	372	6.6	0.69	16	-	-	-	-
	20	1072	522	8.0	0.92	21	-	-	-	-
800	-	-	-	-	-	06	430	209	5.4	0.41
	10	524	255	6.0	0.52	11	-	-	-	-
	15	872	425	7.5	0.78	16	-	-	-	-
	20	1226	597	9.1	1.06	21	-	-	-	-
900	-	-	-	-	-	06	484	236	6.0	0.46
	10	590	287	6.8	0.59	11	-	-	-	-
	15	981	478	8.5	0.88	16	-	-	-	-
	20	1379	672	10.3	1.19	21	-	-	-	-
1000	-	-	-	-	-	06	538	262	6.7	0.51
	10	655	318	7.5	0.65	11	-	-	-	-
	15	1090	531	9.4	0.98	16	-	-	-	-
	20	1532	746	11.4	1.32	21	-	-	-	-
1100	-	-	-	-	-	06	592	288	7.4	0.56
	10	721	350	8.3	0.72	11	-	-	-	-
	15	1199	584	10.3	1.08	16	-	-	-	-
	20	1685	821	12.5	1.45	21	-	-	-	-
1200	-	-	-	-	-	06	646	314	8.0	0.61
	10	786	382	9.0	0.78	11	-	-	-	-
	15	1308	637	11.3	1.18	16	-	-	-	-
	20	1838	895	13.7	1.58	21	-	-	-	-
1400	-	-	-	-	-	06	753	366	9.4	0.71
	10	917	446	10.5	0.91	11	-	-	-	-
	15	1526	743	13.2	1.37	16	-	-	-	-
	20	2145	1045	16.0	1.85	21	-	-	-	-
1600	-	-	-	-	-	06	861	419	10.7	0.82
	10	1048	509	12.0	1.04	11	-	-	-	-
	15	1744	850	15.0	1.57	16	-	-	-	-
	20	2451	1194	18.2	2.11	21	-	-	-	-
1800	-	-	-	-	-	06	968	471	12.1	0.92
	10	1179	573	13.5	1.17	11	-	-	-	-
	15	1962	956	16.9	1.76	16	-	-	-	-
	20	2758	1343	20.5	2.38	21	-	-	-	-
2000	-	-	-	-	-	06	1076	524	13.4	1.02
	10	1310	637	15.0	1.30	11	-	-	-	-
	15	2180	1062	18.8	1.96	16	-	-	-	-
	20	3064	1493	22.8	2.64	21	-	-	-	-
2400	-	-	-	-	-	06	1291	628	16.1	1.22
	10	1572	764	18.0	1.56	11	-	-	-	-
	15	2616	1274	22.6	2.35	16	-	-	-	-
	20	3677	1791	27.4	3.17	21	-	-	-	-
2800	-	-	-	-	-	06	1506	733	18.8	1.43
	10	1834	891	21.0	1.82	11	-	-	-	-
	15	3052	1487	26.3	2.74	16	-	-	-	-
	20	4290	2090	31.9	3.70	21	-	-	-	-

EN442 output at 20°C room temperature.

STRADA - HEAT EXCHANGERS OVERVIEW & PRESSURE DROP

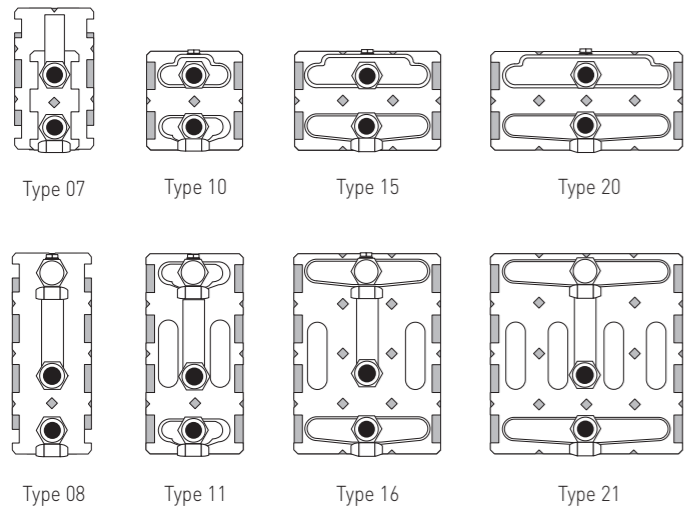

To optimise the output of the type 06 Strada a Type 07 heat exchanger is fitted in the 200mm high casing, and a Type 08 is fitted in all other Type 06 units.

TO CALCULATE FLOW RATE:

$$\frac{\text{Corrected output [Watts]} \times 3600}{\text{Specific heat capacity [J/kg.}^\circ\text{C]} \times [\text{flow temp} - \text{return temp}]}$$

For central heating hot water systems the specific heat capacity of 4187 can be used:

E.g. for a radiator with a 1000 Watt output with a flow temp of 70°C and a return temp of 50°C.

$$\text{Mass flow} = \frac{1000 \times 3600}{4187 \times (70-50)} = 42.99 \text{ kg/hr}$$

PRESSURE DROP TYPE 10

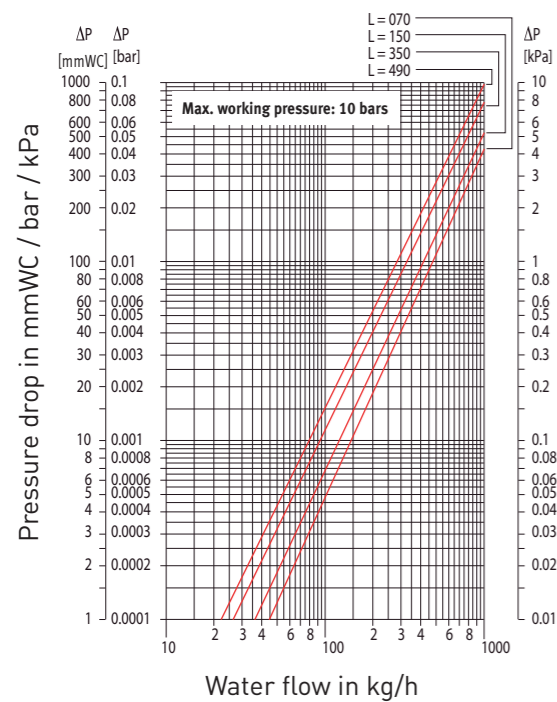

PRESSURE DROP TYPE 08

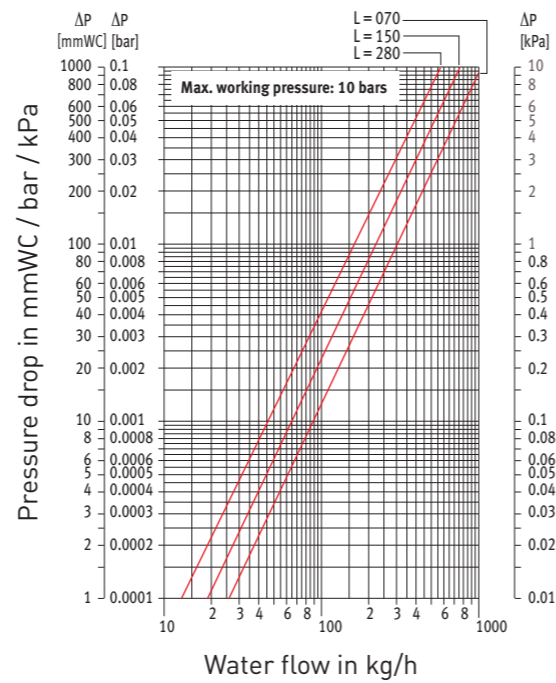

PRESSURE DROP TYPE 15

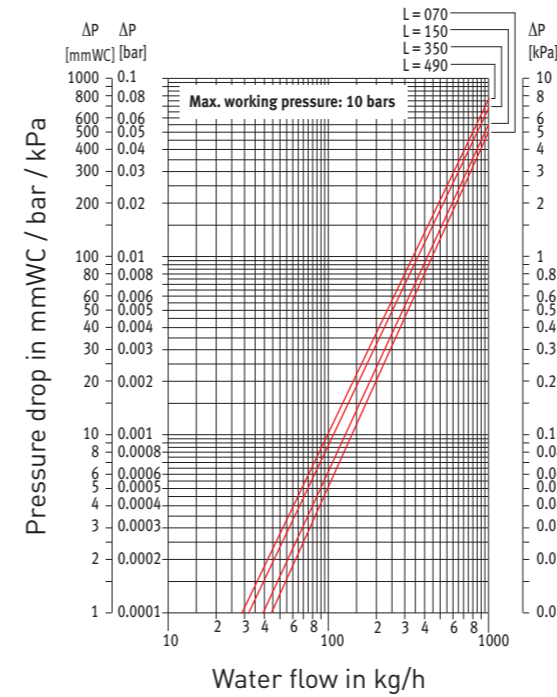

PRESSURE DROP TYPE 16

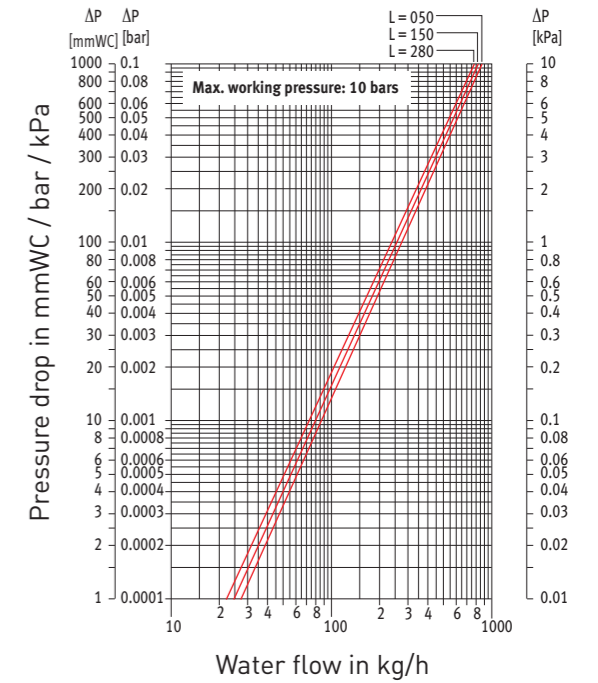

PRESSURE DROP TYPE 11

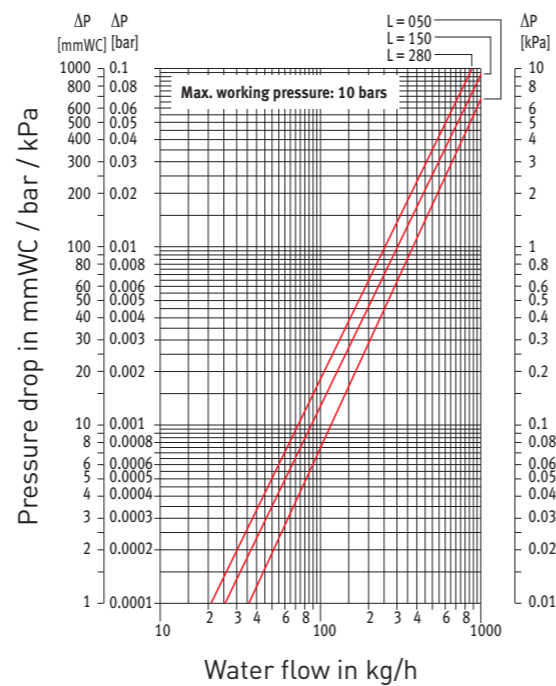

PRESSURE DROP TYPE 20

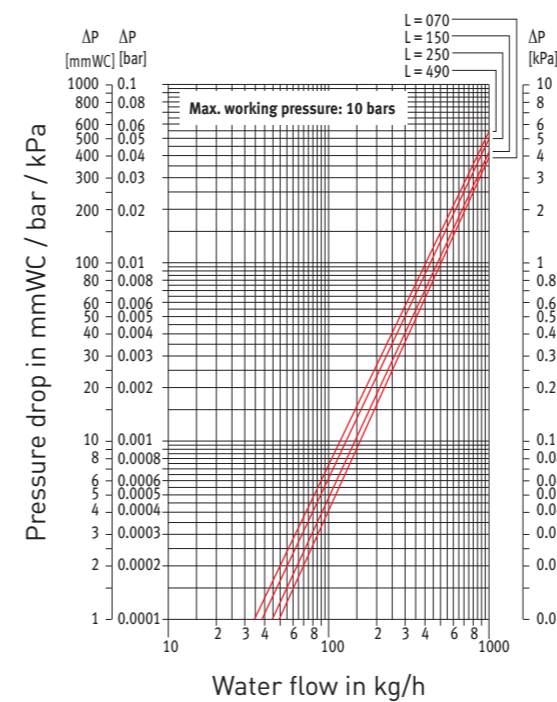

PRESSURE DROP TYPE 21

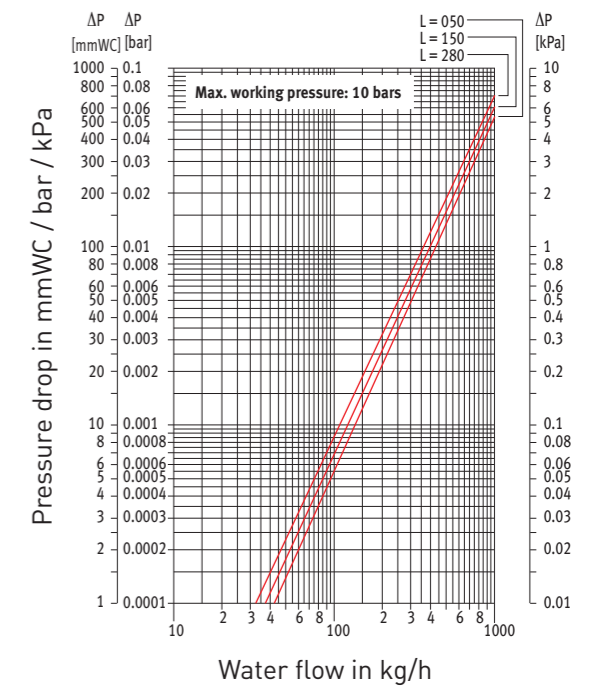

VALVES, TRV HEADS AND ACCESSORIES

OUR SPECIALLY SHORTENED VALVES CAN BE CONCEALED WITHIN THE STANDARD CASING. OTHER VALVES MAY BE PARTIALLY VISIBLE.

SLEEVE COUPLING M24

Copper Tube

CODE	Tube Ø
5094.110	10/1
5094.115	15/1

Steel Tube for C.H

CODE	Tube Ø
5094.501	1/2"

Please note other couplings are available on request.

SLEEVE COUPLING 1/2"

Copper Tube

CODE	Tube Ø
5098.110	10/1
5098.115	15/1

Steel Tube for C.H

CODE	Tube Ø
5094.502	1/2"

Please note other couplings are available on request.

ARTHRITIC AID



CODE
5090.ARTH

JAGA PRO THERMOSTATIC VALVE



- with pre-setting
- for connection to the floor
- for two pipe
- complies to European standard EN 215.1

CODE	Description
5094.4414	Jaga Pro Thermostatic -Valve (M24)
5090.1125	TRV Head (white)

JAGA THERMOSTATIC VALVE - WALL

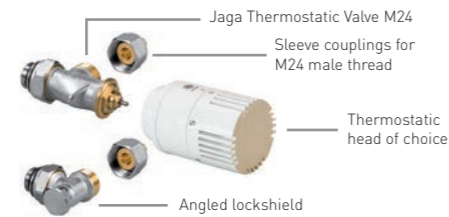

- Consists of the following :
- 5090.407 type 06 angled TRV
 - 5090.111 type 06 angled lockshield valve
 - 5090.1125 white TRV head
 - Adaptors to suit 15mm copper pipe as standard

To suit pipework to wall (Same end 20/70 connections).

CODE	Description
5090.407	Jaga type 06 TRV (M24)
5090.111	Angled T06 Lockshield (M24)
5090.1125	TRV Head (white)

JAGA THERMOSTATIC VALVE - FLOOR

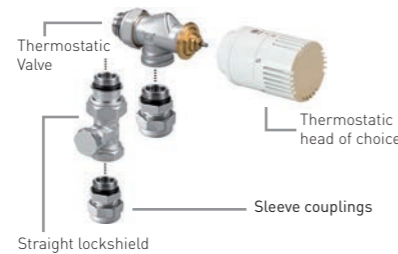

- Consists of the following :
- 5090.405 angled TRV
 - 5090.109 straight lockshield valve
 - 5090.1125 white TRV head
 - Adaptors to suit 15mm copper pipe as standard

To suit pipework from the floor (Same end 20/70 connections).

CODE	Description
5090.405	Jaga angled TRV (1/2")
5090.109	Straight Lockshield (1/2")
5090.1125	TRV Head (white)

HIGH LEVEL JAGA TOP VALVE



- Consists of the following :
- 5090.13001 High Level TRV set (including valve, capillary & head)
 - 5090.1125 white TRV head
 - Adaptors to suit 15mm copper pipe as standard
 - 5090.109 straight lockshield valve OR
 - 5090.110 angled lockshield valve

To suit pipework from the floor or wall (same end 30/60 connections).

CODE	Description
5090.13001	Jaga High Level TRV set (1/2")
5090.110	Angled Lockshield (1/2") (Wall)
5090.109	Straight Lockshield (1/2") (Floor)

TRV HEADS



CODE	CODE	CODE	CODE	CODE
5090.1125	5090.1150	5090.1151	5090.1152	5090.1161

CODE	Description
5090.1125	White (Heating)
5090.1150	White (Heating)
5090.1151	Chrome (Heating)
5090.1152	Silver (Heating)
5090.1161	Heimeier Thermostatic Head HC (Heating + Cooling)

EN442 output at 20°C room temperature

JAGA COLOURS

Jaga colours are divided into three colour groups:

“Subtle & discreet” includes a selection of neutral colours that discreetly blend our units into the interior.

“Colours of nature” is a collection of 16 colours containing bright, variegated, greyish and pastel shades. From soft natural colours to dark chic. For the bold.

“Precious metals” includes metal lookalikes, in harmony with trends in the world of taps, lighting and bathroom accessories.

Jaga has environmentally-friendly electrostatic powder coating lines. Excess powder is recuperated and no solvents are used during this process.

After having been thoroughly pretreated, the units are powder coated and baked. This ensures that the unit is both UV and scratch resistant.

What does the first digit of the colour code stand for?

Code 1xx Soft touch: finely-textured matte look, gloss degree < 10%

Code 0xx Metal lookalikes: the finish and the degree of gloss simulate the imitated material

Standard colours

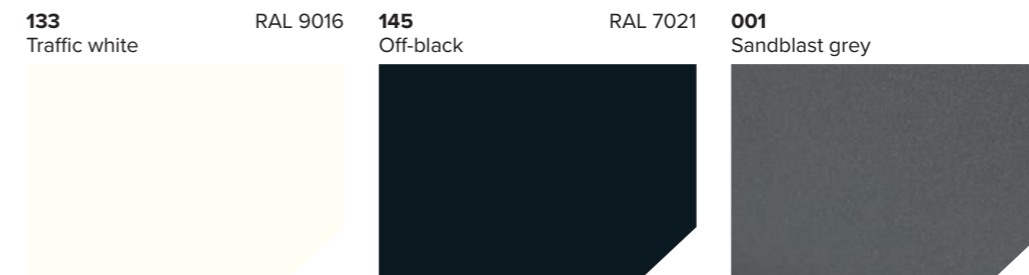

Special colours

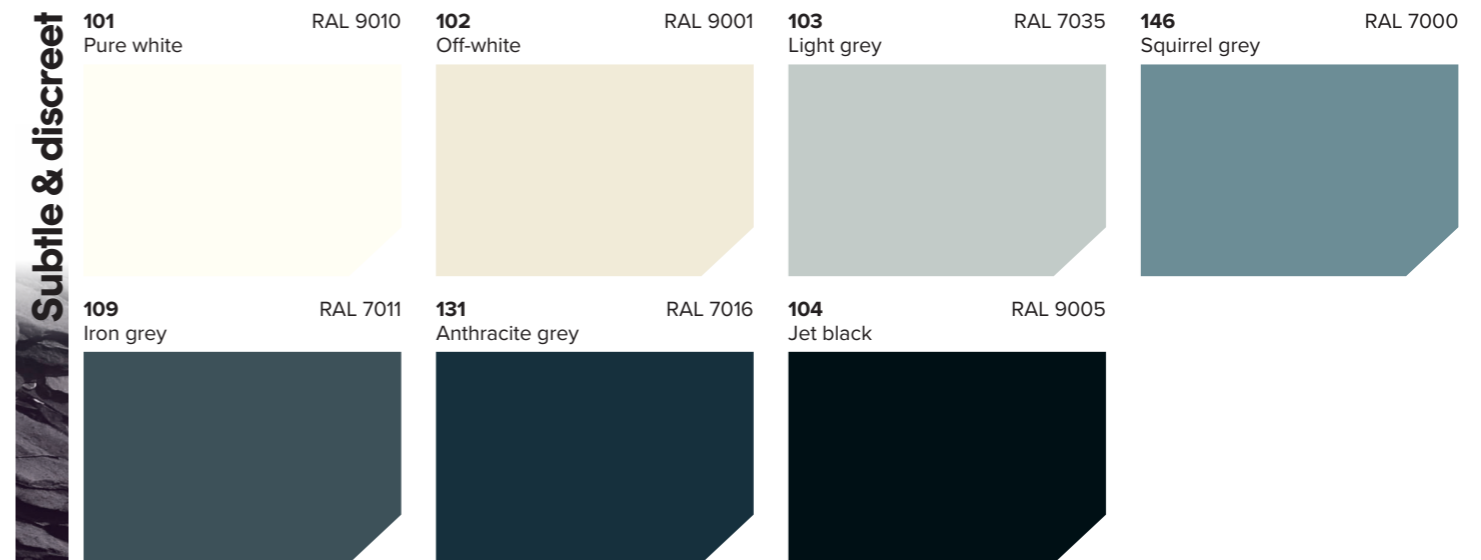

This colour chart is only indicative. It's impossible to obtain a 100% exact colour reproduction in printing. A colour chart can be obtained on request. The rendering of "055 Corten steel look" gives an impression of the end result. Due to the uniqueness of the surface, the lacquer, and the applied techniques, each device will be unique.

Colours of nature

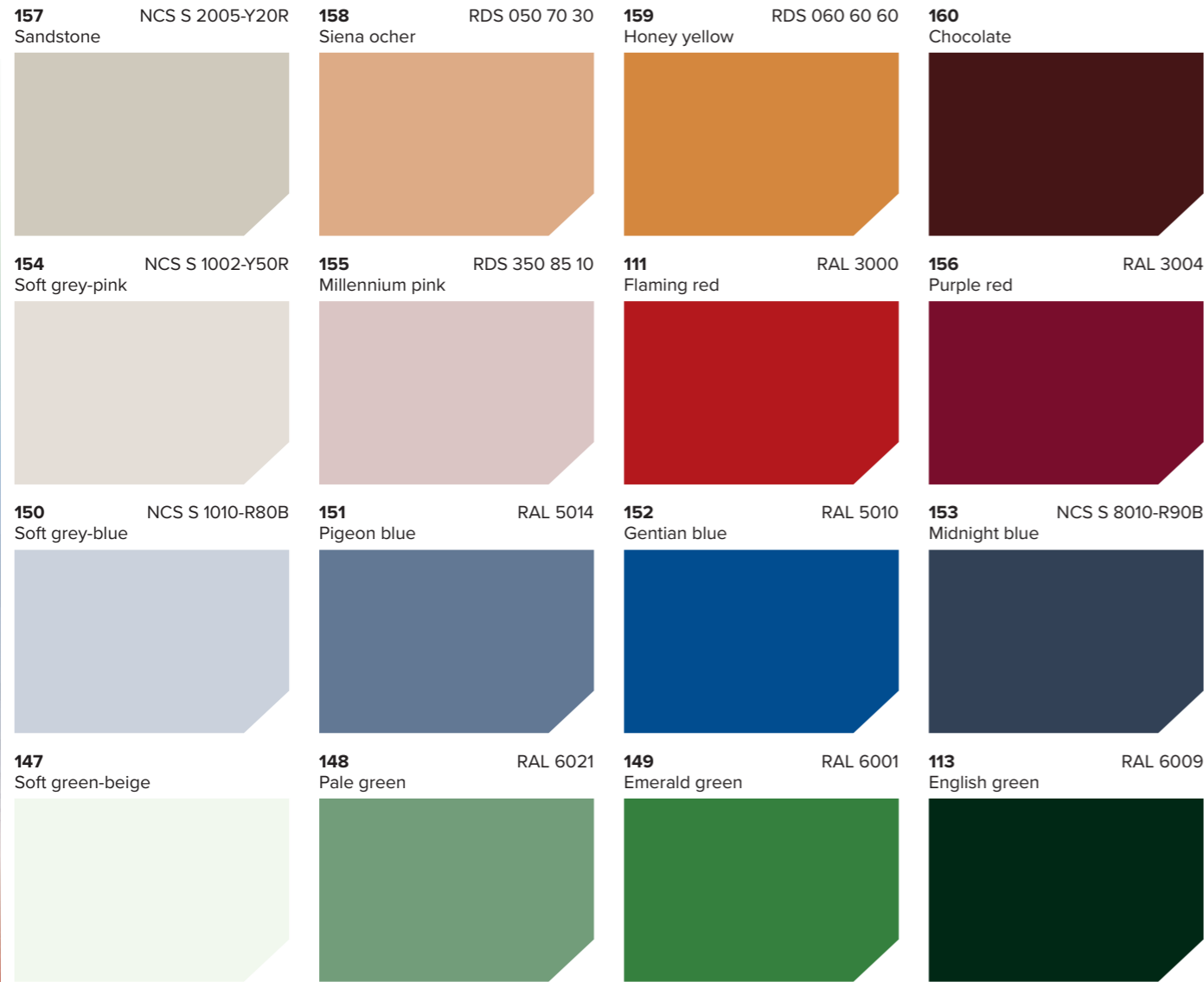

Precious metals

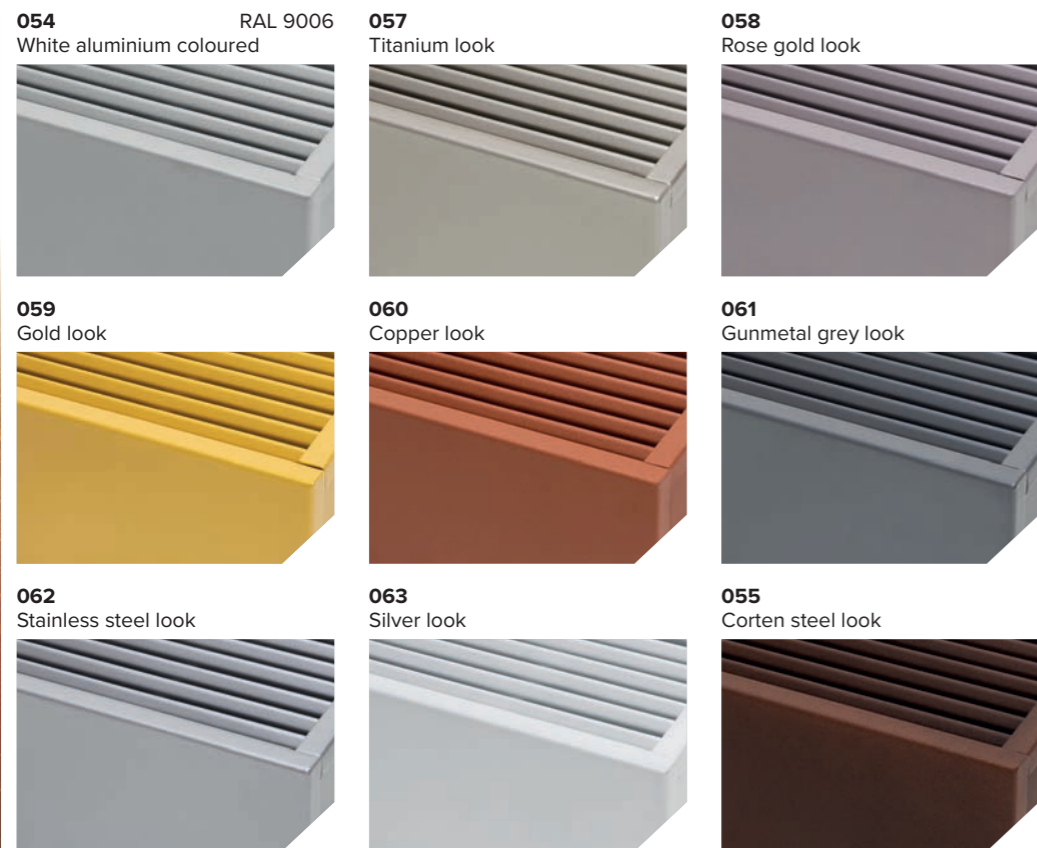

NOTES



jaga
CLIMATE DESIGNERS

Jaga reserves the right to change product specification at any time in line with our policy of continuous improvement and innovation.

STRADA0423 - JAGA

red.dwarf

📄 www.reddwarf.co.nz

☎ (03) 982 3852.

📍 21 Humphreys Drive, Ferrymead, Christchurch, 8023.